

LUCINI

Freestanding Bath 1700mm Matte Black

7
YEAR
WARRANTY

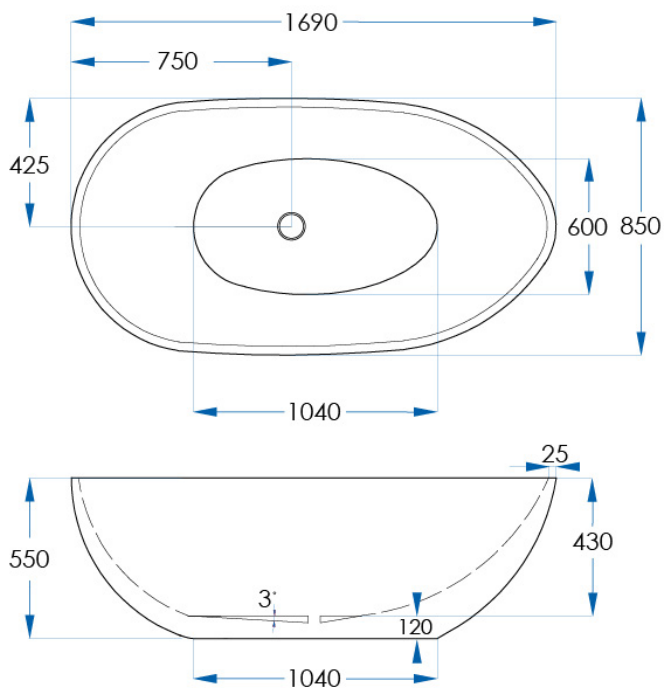

SPECIFICATIONS

Size	1690x850mm
Height	550mm
Material	Sanitary Grade Acrylic
Waste Size	40mm
Capacity	300L
Weight	53kg
Code	LUC1700-MB
Warranty	7 year replacement product (bath shell): 1 year labour

CASA LUSO

Due to our policy of continuous development, all designs and measurements are intended only as a guide and are subject to change without notice. Being hand made products they are subject to a size variance E&OE. This brochure is representative of the actual products at time of printing. Please confirm all particulars before purchase. Casa Lusso recommends having the product on site before commencing rough in.

Available at

hb Highgrove Bathrooms
www.highgrovebathrooms.com.au